

**Rocker Switch (RS8-2 Series)**



**SPECIFICATIONS**



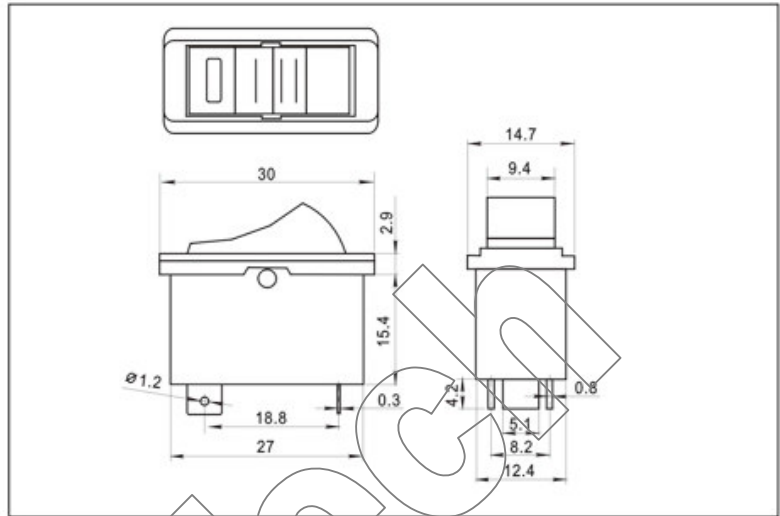

10 (2) A 250VAC 5E4  
 16 (3) A 250VAC 1E4 T85/55  
 16A 125V 1E4 T85  
 10A 250VAC

**ROHS Compliance**

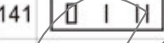
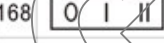

EXPLANATION MODEL NUMBER

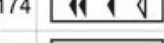
**RS8 - 2 - 141 - BK/BK - P47**

Cap Printing	
0	None
139	
141	
168	
169	
171	
174	
152	
152/TS	*152" by tooling
141/TS	*141" by tooling

Color Cap/Housing	
BK	Black
RE	Red
BR	Brown

